



#### **COPYRIGHT AND TRADEMARKS**

All copyright and other intellectual property rights in the information contained in this website (including but not limited to text, images, and software) are owned by Hapro International bv. Persons, accessing this website are permitted to download extracts of this website. But in all cases only for personal, informational and non-commercial purposes. No reproduction may be sold or distributed for commercial gain nor be modified or incorporated in any other work, publication or website. No other rights or licenses are assigned or shall otherwise pass to persons accessing this website. All trademarks are emblems displayed on this website are owned or used under license by Hapro International bv.

#### **COPYRIGHT AND TRADEMARKS**

De bestanden op [www.hapro.com](http://www.hapro.com) mogen vrij gedownload worden mits aan de volgende voorwaarden wordt voldaan. Alle gegevens mogen enkel voor eigen gebruik worden toegepast. Het materiaal mag op generlei wijze aan derden worden verstrekt of openbaar worden gemaakt. Zonder uitdrukkelijke toestemming van Hapro mogen bestanden, logo's, beeldmateriaal of delen daarvan niet worden hergebruikt. Met het downloaden van materiaal van [www.hapro.com](http://www.hapro.com) verklaart de gebruiker met deze voorwaarden in te stemmen. Hapro behoudt zich het recht voor om schenders van het auteursrecht te vervolgen.

#### **COPYRIGHT UND WARENZEICHEN**

Sämtliche Inhalte dieser Webseite (Texte, Bilder und Software) sind Eigentum von Hapro International bv. und urheberrechtlich geschützt. Ausschließlich zur persönlichen Nutzung (private, persönliche, informelle Zwecke) dürfen Inhalte dieser Webseite heruntergeladen werden. Jegliche gewerbliche Nutzung von heruntergeladenen Inhalten dieser Webseite ist jedoch untersagt. Inhalte dürfen weder verkauft noch zu gewerblichen Zwecken verbreitet werden und nicht in andere Veröffentlichungen oder Internetseiten übernommen werden, auch nicht in veränderter Form. Außerhalb der eingeräumten Nutzungsrechte werden dem Nutzer keine weiteren Rechte eingeräumt. Alle auf dieser Webseite gezeigten Warenzeichen sind Eigentum von Hapro International bv. oder werden von Hapro International bv. mit Lizenz verwendet. Durch den Download bei [www.hapro.com](http://www.hapro.com) erklärt sich der Nutzer dieser Webseite mit diesen Bedingungen einverstanden. Hapro behält es sich vor, Verletzungen des Urheberrechts zu verfolgen.



IT'S YOUR BODY  
*Luxura*  
by Hapro

X<sub>3</sub>



First class manufacturing quality, high quality engineering, and modern design. Welcome to the quality world of Luxura.



## My Place In The Sun

Enjoy luscious sunshine whenever you wish.

Come and join the luxury world of Luxura. Experience the difference. The  $x_3$  will fulfil your professional requirements.

Luxura  $x_3$ : first-class design for a first-class tan. Your own personal place in the sun.



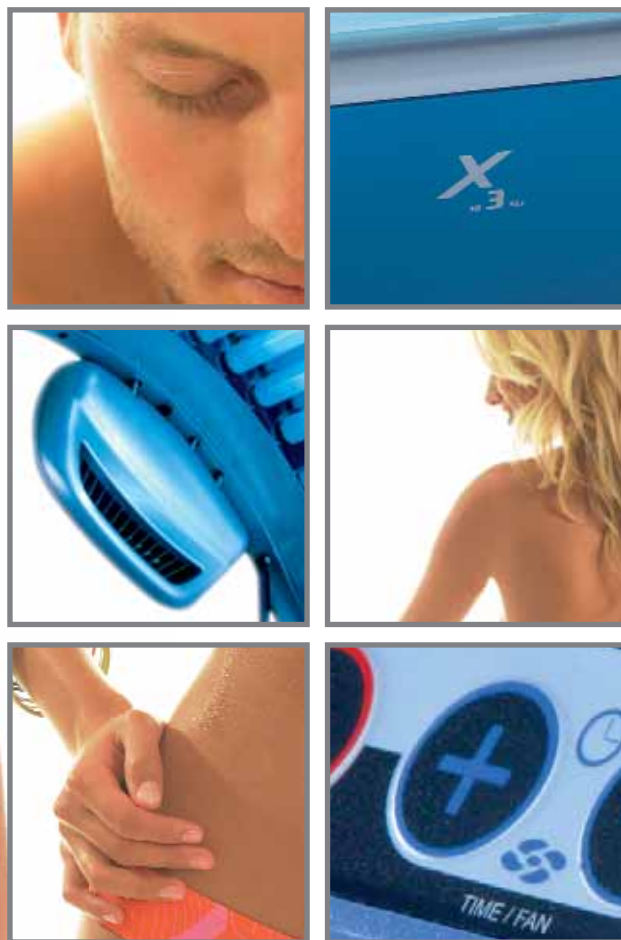

## Customised Wellness

As an entry-level model, the Luxura x<sub>3</sub> is in a class of its own. And what a class it is! Whether you prefer the space-saving shorter version or the luxurious long model, whatever you choose, you will be able to select between four possible configurations for your sunbed. The Luxura x<sub>3</sub> is not only perfect for regular tanning salons but is also just the right choice for beauty or hairdressing salons, physiotherapy practices or swimming pools.

The logo for the Luxura X3 tanning bed, featuring a large, stylized 'X' with a '3' underneath it.



Lie down in comfort.





## The Look Of Quality From The Outside

The brilliance of the external panels radiates the flavour of futuristic high tech. What is more, if you choose the decorative silver screen, it will reflect positively on the atmosphere of the entire area surrounding the sunbed. The metallic silver side covers add to the elegance of the Luxura x<sub>3</sub> and will ensure plenty of admiring glances.



X<sub>3</sub>





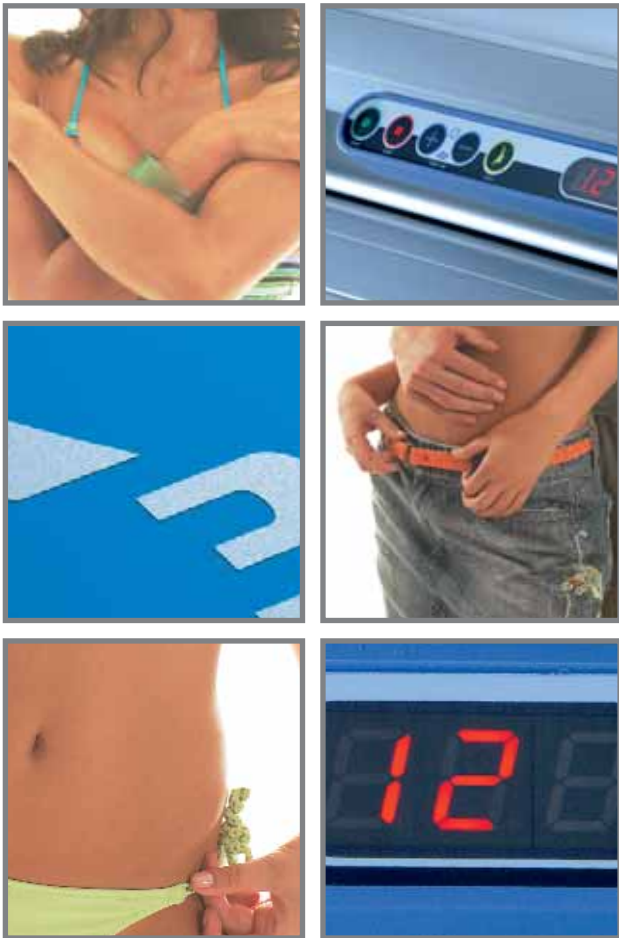

## The Time Has Come

The time you spend on a sunbed is too precious to have to waste it on technical matters. If you are seeking wellness and relaxation, the last thing you want is to spend your time getting to grips with complicated keyboards. That is why a few finger movements are all you need to regulate the body and face coolers or activate the facial tanner. The user can operate the timer himself or it is controlled centrally from the tanning studio. Of course, it is also possible to fit an external timer, for example a coin-operation mechanism. The time of the Luxura x<sub>3</sub> has come.

X<sub>3</sub>





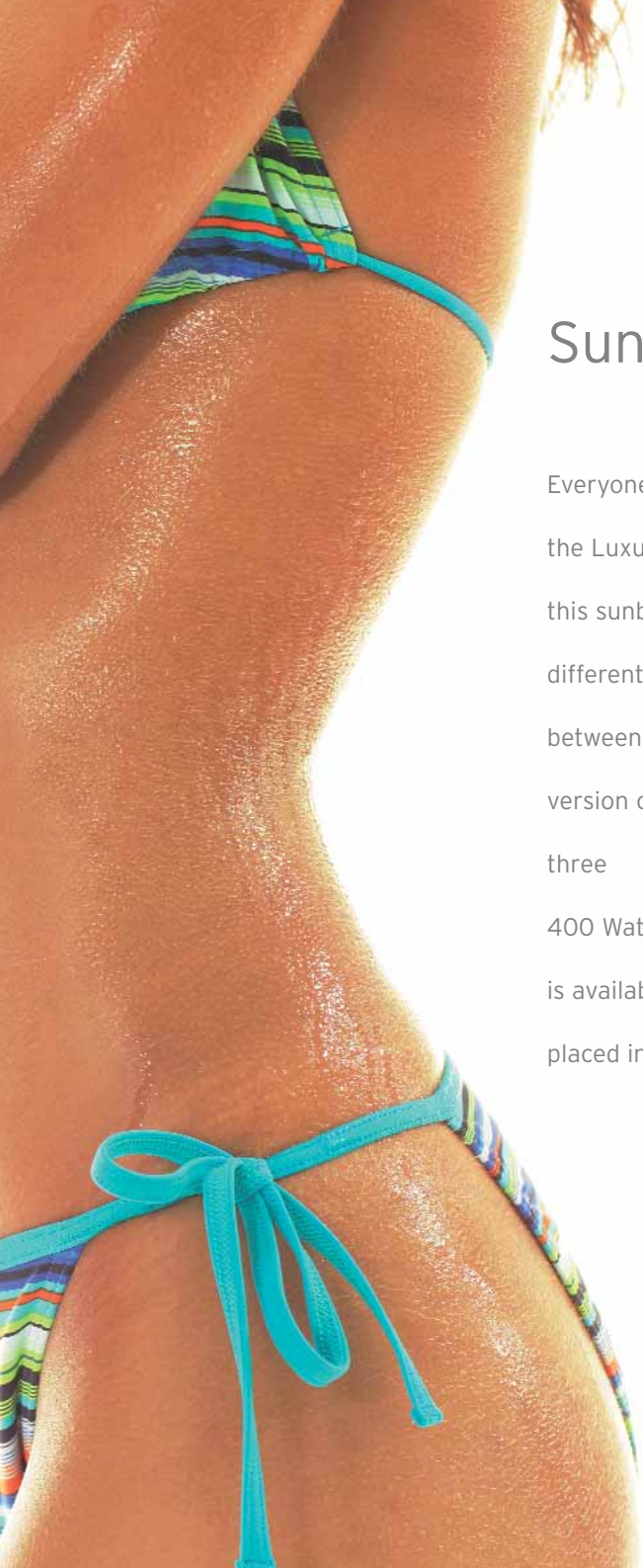

## Sun To Order

Everyone has different wishes, as different as the Luxura  $x_3$  models themselves. That is why this sunbed is available with a choice of four different tube configurations. You can choose between 26 SLi, 28 SLi, 30 SLi or 30 SPr. Each version can be equipped with either one or three 400 Watt facial tanners. The 30 SPr version is available with nine 25-W reflector tubes, placed in-between the standard tubes.

 30 SPr



All the models in the pictures are equipped with the optional decoration shield between top and base.

X<sub>3</sub> 30 SLi



X<sub>3</sub> 26 SLi



The face-tanning unit (with the special reflector casing, high pressure lamp and blue filter) can be activated separately.



## Lie Down In Comfort

What a wellness luxury it is to stretch out on a long sunbed!

However, if the dimensions of the sunbed cubicles or room don't allow for this, then simply choose the shorter length version.

It saves space and it's tanning effect is just the same as the longer one. A central air outlet is not required in either version. The optional available face cooler is just right for an invigorating cooling sensation. Who would want to do without it?

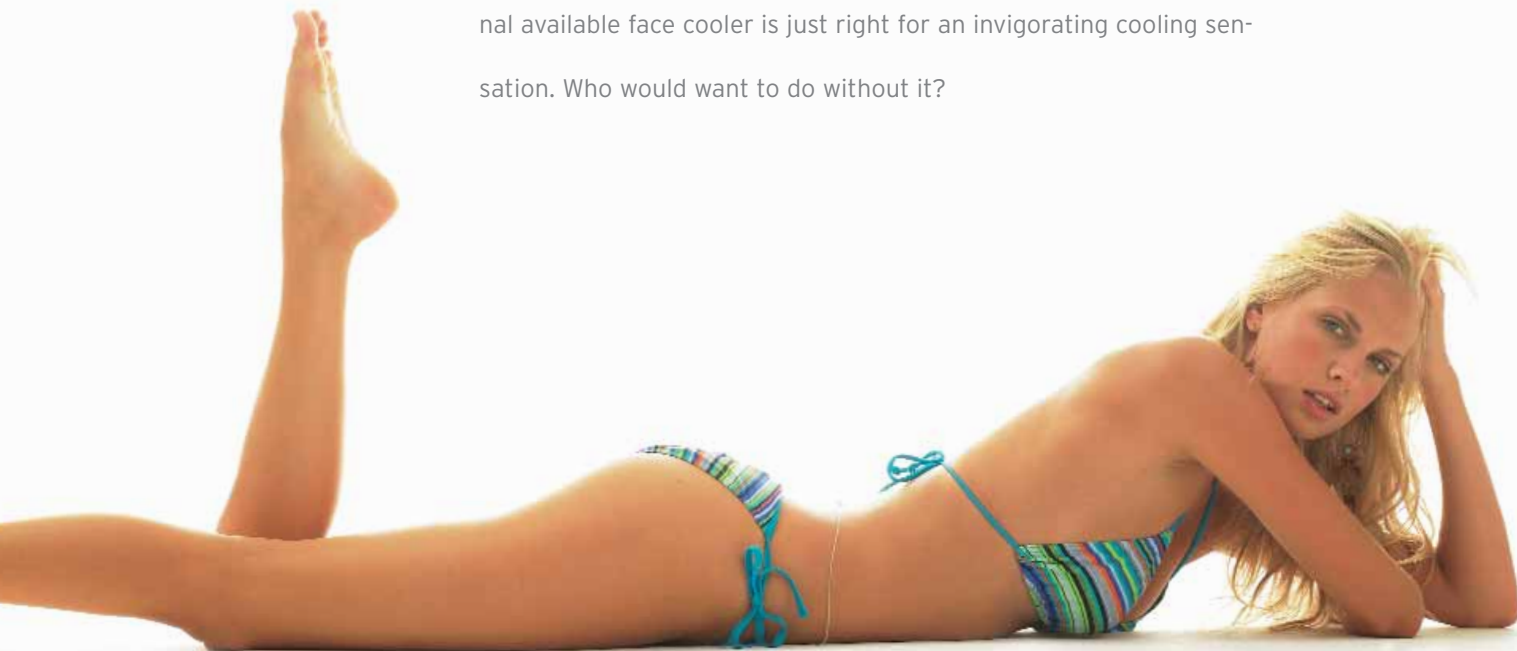

Always keep a cool head!  
The adjustable face cooler keeps you feeling comfortable. (optional)



X<sub>3</sub>



An invitation to sunbathing in luxury. Just lie down in comfort.

# It Can Be So Simple

The Luxura concept offers a high degree of comfort, and not only to sun worshippers. Maintenance personnel will notice that the work procedures are particularly easy to perform. For instance, the click-strip system of the acrylic base makes the regular maintenance child's play. It is removed quickly and replaced just as quickly. The same goes for the panels that house the electrical components. The only thing that you are likely to find difficult, is to decide which model is the best for you.

And the bigger the choice, the harder it is. But take your time. No stress!

Eternal blue



Click-Strip-System for easy removal of acrylic shield.

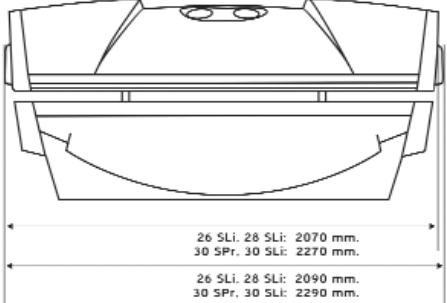
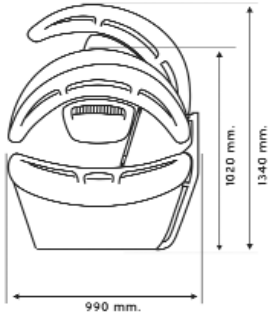

	<b>26 SLi</b>	<b>28 SLi</b>	<b>30 SLi</b>	<b>30 SPr</b>
surface	Metallic effect	Metallic effect	Metallic effect	Metallic effect
Tubes top	10 x 100 W 4 x 80 W	14 x 80 W	16 x 100 W	16 x 120 W*
Tubes base	12 x 100 W	14 x 100 W	14 x 100 W	14 x 100 W
Face tanner	1 x 400 W	3 x 400 W	3 x 400 W	9 x 25 W
Luxura filter technology	●	●	●	●
Face cooler	○	○	○	○
Click-Strip-System	●	●	●	●
Decorative silver screen between top and base	○	○	○	○
Digital timer display	●	●	●	●
Programmable internal timer	●	●	●	●
Connection for external timer	●	●	●	●
Hour counter	●	●	●	●
Connection	230V/50Hz/ 1~N/PE	400V/50Hz/ 3~N/PE	400V/50Hz/ 3~N/PE	400V/50Hz/ 3~N/PE
Power	3.6 kW	5.0 kW	5 kW	4.0 kW
Fuses	1x 16 A	3x 16 A	3x 16 A	3x 16 A
Weight	150 kg	170 kg	180 kg	167 kg

● = As standard, ○ = Optional

\*2 m XL tubes

Specifications are subject to change without notice.  
The devices shown sometimes include special equipment.

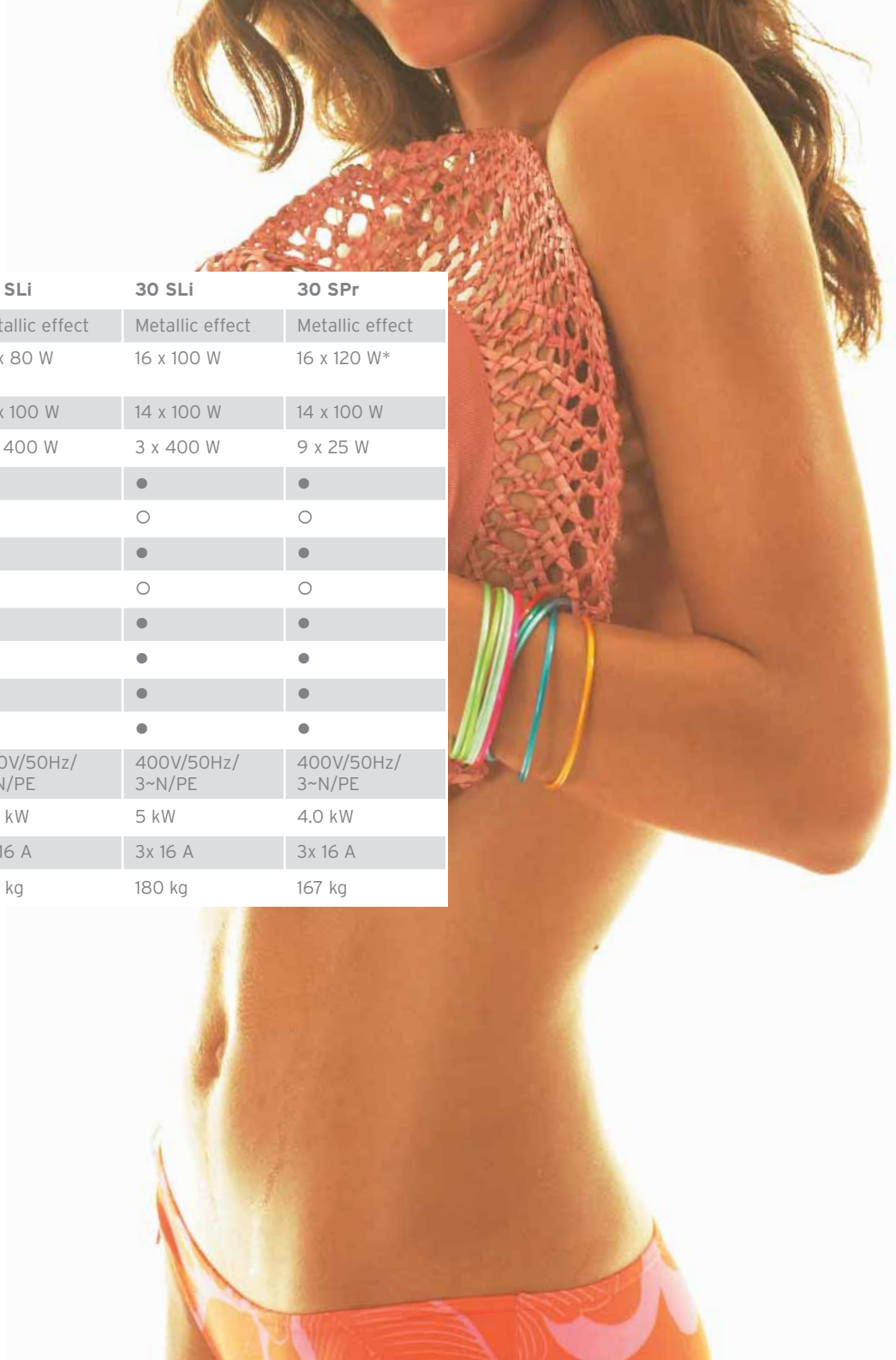





[www.hapro.com](http://www.hapro.com)

Hapro International bv · P.O. Box 73 · 4420 AC Kapelle · The Netherlands